

mvBlueFOX3-5M

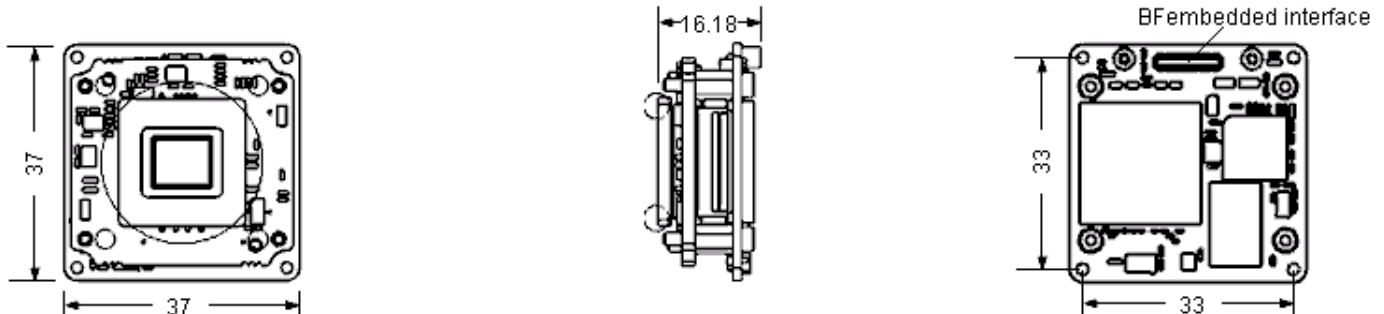

Dimensions in mm



Sensors

BF3-5M		Resolution (H x V pixels)	Sensor size (optical)	Pixel size (µm)	Frame rate ¹	Sensor technology	Readout type	ADC resolution / output in bits	Sensor
-0004F	G/C	728 x 544	1/2.9"	6.9 x 6.9	436.9	CMOS	Global	12 / 12	Sony IMX287
-0016Z	G/C	1456 x 1088	1/2.9"	3.45 x 3.45	226.5	CMOS	Global	12 / 12	Sony IMX273
-0024Z	G/C	1936 x 1216	1/1.2"	5.86 x 5.86	161.4	CMOS	Global	12 / 12	Sony IMX174
-0024A	G/C	1936 x 1216	1/1.2"	5.86 x 5.86	46.9	CMOS	Global	12 / 12	Sony IMX249
-0032Z	G/C	2064 x 1544	1/1.8"	3.45 x 3.45	119.2	CMOS	Global	12 / 12	Sony IMX252
-0032A	G/C	2064 x 1544	1/1.8"	3.45 x 3.45	55	CMOS	Global	12 / 12	Sony IMX265
-0051Z	G/C	2464 x 2056	2/3"	3.45 x 3.45	75	CMOS	Global	12 / 12	Sony IMX250
-0051P	G/C	2464 x 2056	2/3"	3.45 x 3.45	75	CMOS	Global	12 / 12	Sony IMX250_POL
-0051A	G/C	2464 x 2056	2/3"	3.45 x 3.45	35	CMOS	Global	12 / 12	Sony IMX264
-0064Z	G/C	3096 x 2080	1/1.8"	2.4 x 2.4	59	CMOS	Rolling	12 / 12	Sony IMX178
-0089Z	G/C	4112 x 2176	1"	3.45 x 3.45	42.4	CMOS	Global	12 / 12	Sony IMX255
-0089A	G/C	4112 x 2176	1"	3.45 x 3.45	31.9	CMOS	Global	12 / 12	Sony IMX267
-0124Z	G/C	4112 x 3008	1.1"	3.45 x 3.45	30.7	CMOS	Global	12 / 12	Sony IMX253
-0124A	G/C	4112 x 3008	1.1"	3.45 x 3.45	23	CMOS	Global	12 / 12	Sony IMX304
-0124R	G/C	4064 x 3044	1/1.7"	1.85 x 1.85	30.7	CMOS	Rolling	12 / 12	Sony IMX226
-0162A	G/C	5328 x 3040	1.1"	2.74 x 2.74	23.4	CMOS	Global	12 / 12	Sony IMX542
-0204A	G/C	4512 x 4512	1.1"	2.4 x 2.4	18.6	CMOS	Global	12 / 12	Sony IMX541
-0205Z	G/C	5544 x 3692	1"	2.4 x 2.4	18.5	CMOS	Rolling	12 / 12	Sony IMX183
-0246A	G/C	5328 x 4608	1.2"	2.74 x 2.74	15.4	CMOS	Global	12 / 12	Sony IMX540
-0315Z	G/C	6480 x 4856	APS-C	3.45 x 3.45	12	CMOS	Global	12 / 12	Sony IMX342

¹ Streaming frame rate (burst mode frame rates see website)

Hardware Features

Protocol	Compliant to USB3 Vision
Interface	USB 2.0 / 3.0 (up to 480 Mbit/s / up to 5 Gbit/s)
Image formats	Mono8/10/12/14/16 BayerGR8/10/12/16, RGB8Packed, BGR8Packed, BGRA8Packed, BGR10V2Packed, YUV422/444Packed, YUV422_YUYVPacked onboard color processing
Triggers	External, software based or free run
Size w/o lens (W x H)	37 x 37 mm
Weight w/o lens; base module	approx. 6 g
Permissible ambient temperature	Operation: 0...45 °C / 30 to 80 % RH Storage: -20...60 °C / 20 to 90 % RH
Lens mounts	S-mount, C-mount, CS-mount available
Digital I/Os	4 / 4 CMOS/TTL with adjustable I/O levels
Image memory / Flash (firmware, calibration, user data)	256 MBytes, 16 MBytes
Conformity	CE, FCC, RoHS
Driver	mvIMPACT Acquire SDK or any USB3 Vision compliant interface or vision library for Windows®, Linux® (32 bit & 64 bit)
Special features	Burst mode, onboard color processing, frame average